

3D VIEW

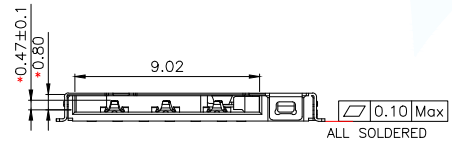

PIIN/NO	ASSIGNMENT
C1	VCC
C2	RST
C3	CLK
CD	Detect Switch
C5	GND
C6	VPP
C7	I/O

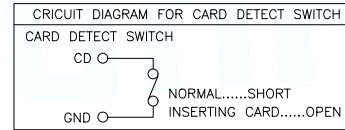

NOTES:

- MATERIAL:**
HOUSING: High Temperature Thermoplastic
Terminal: Copper Alloy
Shell: Stainless Steel
- PLATING:**
Terminal: 50u" Ni UNDERPLATED OVERALL
G/F PLATED ON CONTACT AREA AND SOLDER AREA
Shell: 30u" Ni UNDERPLATED OVERALL
G/F PLATED ON CONTACT AREA AND SOLDER AREA
- TECHNICAL SPECIALITY:**
RATED VOLTAGE: 30V AC MAX.
CURRENT RATING: 0.5A MAX.
INSULATION RESISTANCE: 1000MΩ MIN
CONTACT RESISTANCE: 50mΩ MAX
WITHSTANDING VOLTAGE: 500V AC FOR 1 MINUTES
OPERATING TEMPERATURE:
-25℃~+85℃ Humidity 80% R.H MAX
- DIMENSIONS WITH MARK " * " MUST BE MEASURE BY QC AND IPQC**

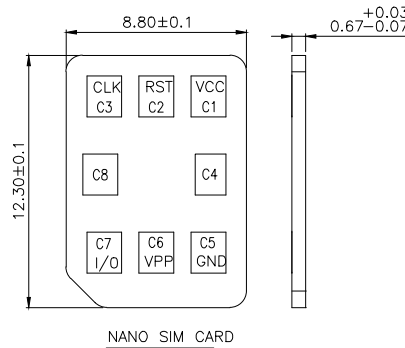

NANO SIM CARD

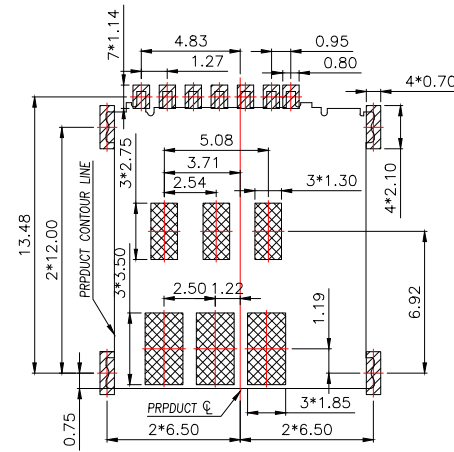

RECOMMENDED PCB LAYOUT TOP VIEW (TOLERANCE: ±0.05)
RECOMMENDED METAL MASK T=0.12mm

- SMT SOLDER AREA
- NO PATTERN AND VIA HOLE IN THIS AREA

MANUFACTURE DWG		东莞市讯普电子科技有限公司 DongGuan XunPu Electronics Co., Ltd	
UNLESS OTHERWISE SPECIFIED TOLERANCES			TITLE: NANO SIM CARD 1.37H PUSH PUSH 无桩
			PAR SMN-303-ARP7
DECIMALS:	ANGLES:		DWN
X.: ±0.35	X': ±2'		CHKD
.X: ±0.15	.X': ±1'		APVD
.XX: ±0.10	.XX': ±0.5'		SCALE: 1:1
		CUSTOMER COPY	SIZE: A4
			SHEET: 1F1
			REV: A

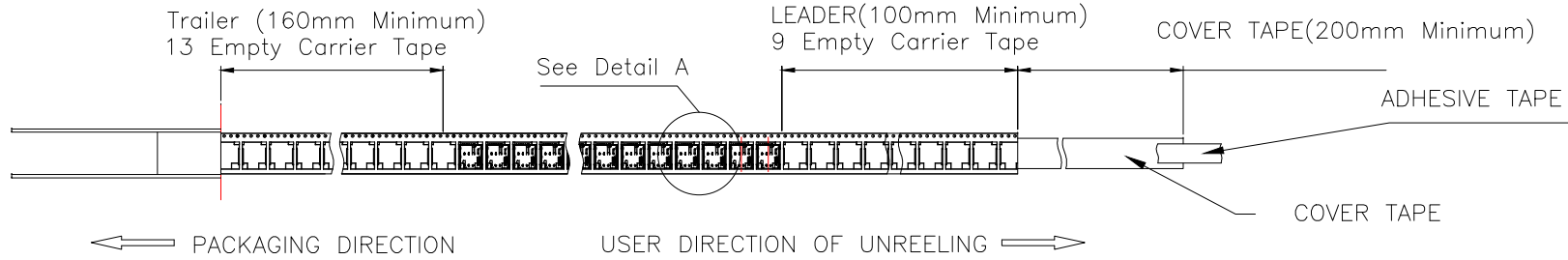

COVER TAPE PEELING ANGLE: 165°~180°
 PEELING FORCE: 20~130g

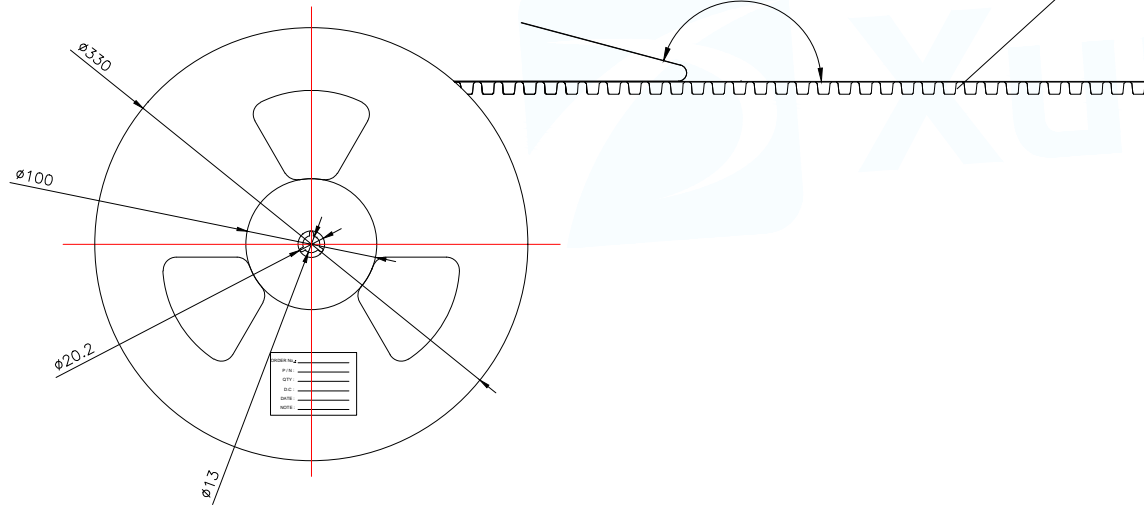

PACKAGING DIRECTION ← → USER DIRECTION OF UNREELING

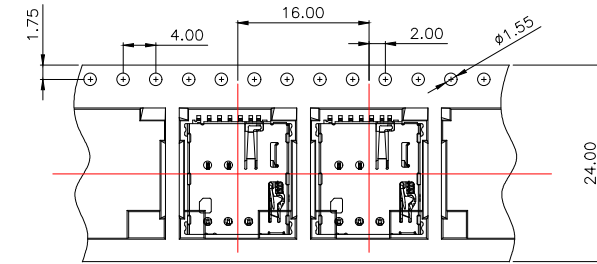

DETAIL A

1	SMN-303-ARP7	1500	10		15000	350X350X340
ITEM	PRODUCT NO	QTY/REEL	REEL/CARTON	Kg/CARTON	QTY/CARTON	CARTON SIZE

MANUFACTURE DWG		 东莞市讯普电子科技有限公司 DongGuan XunPu Electronics Co.,Ltd	
UNLESS OTHERWISE SPECIFIED TOLERANCES			TITLE: NANO SIM CARD 1.37H PUSH PUSH 无柱
			PAR SMN-303-ARP7
			DWN
			CHKD
DECIMALS:	ANGLES:	APVD	
X.: ±0.35	X': ±2'	SCALE 1:1 UNIT: MM	
.X: ±0.15	.X': ±1'	SIZE: A4	
.XX: ±0.10	.XX': ±0.5'	CUSTOMER COPY	SHEET: 1F1
			REV: A